



MASALTA®



PARTS MANUAL FLOOR SAW MF16



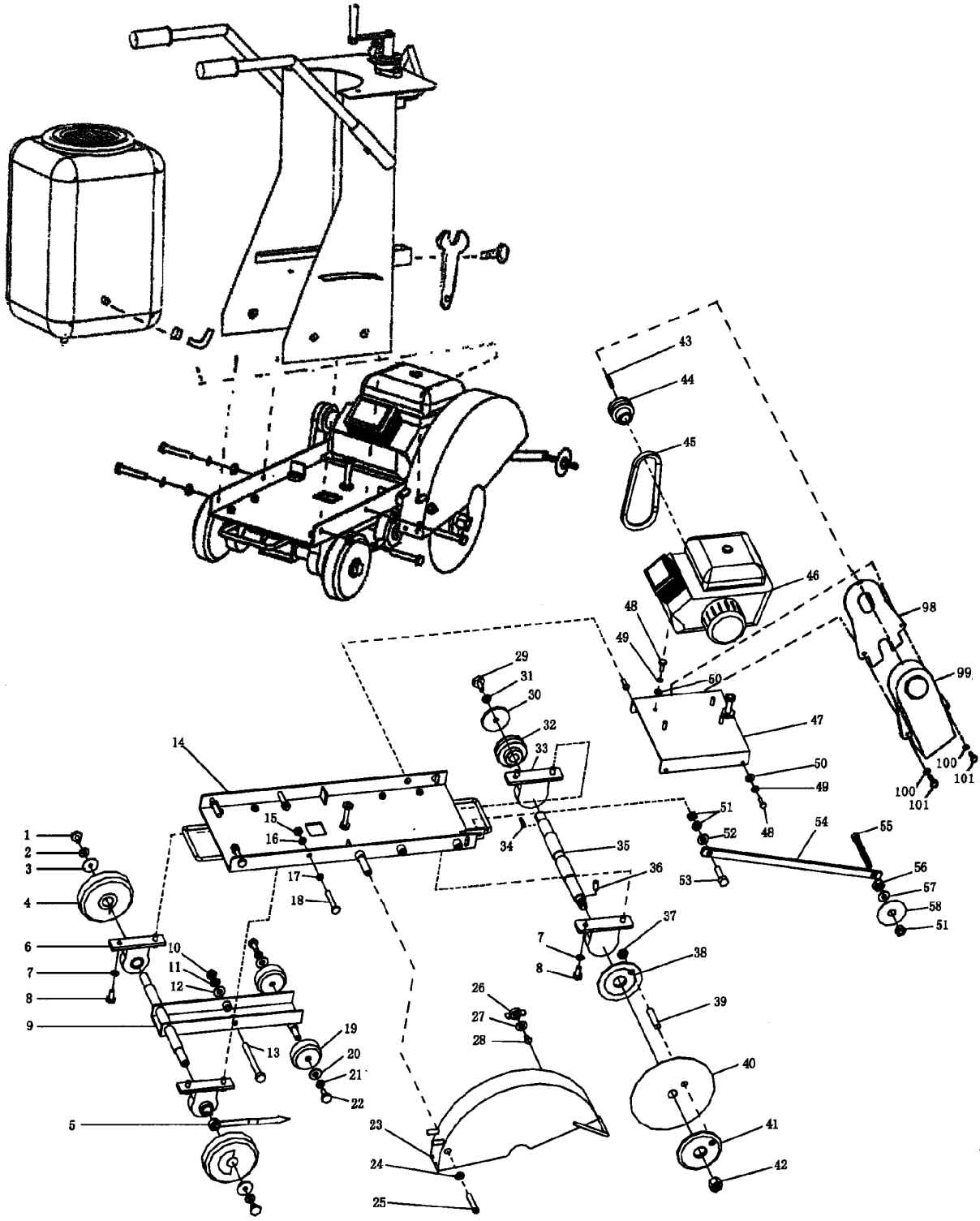

MF16 PARTS LIST 1

MF16 PARTS LIST 1

ITEM NO.	PART NO.	DESCRIPTION	QTY	ITEM NO.	PART NO.	DESCRIPTION	QTY
1	05780012	BOLT M12X20-GB5780	2	35	18090002	PRINCIPAL AXIS	1
2	09300012	SPRING WASHER 12-GB93	2	36	01190006	PIN C6 - GB119	1
3	18030104	DEEP WASHER	2	37	06170008	NUT M8 - GB6170	1
4	00180303	RUBBER WHEEL (REAR)	2	38	18090301	BLADE FLANG (INNER)	1
5	18030103	INDICATOR	1	39	07300008	PIN	1
6	00180302	BEARING & BRACKET	2	40	00180007	BLADE	1
7	09300012	SPRING WASHER 12-GB93	8	41	18090302	BLADE FLANG (OUT)	1
8	05780012	BOLT M12-GB5780	8	42	18090004	NUT	1
9	18030101	WHEEL RACK MODULE	1	43	01096000	KEY - GB1096	1
10	06187012	NUT 12-GB848	1	44	18110001-1	EINGINE PULLEY FOR DIESEL	1
11	09300012	SPRING WASHER 12-GB93	1		18110001-2	ENGINE PULLEY FOR HONDA	1
12	08480012	WASHER 12-GB93	1		18110001-3	ENGINE PULLEY FOR ROBIN	1
13	05784012	BOLT M12 X 120 - GB5784	1	45	01154400-1	V-BELT SPA-GB11544 FOR DIESEL	1
14	18100000	BASE ASSY	1		01154400-2	V-BELT SPA-GB11544 FOR PETROL	1
15	06170012	NUT M12 - GB6170	4	46	00181100-1	DIESEL ENGINE	1
16	09300012	SPRING WASHER 12-GB93	4		00181100-2	HONDA ENGINE	1
17	09700012	WASHER 12-GB97	4		00181100-3	ROBIN ENGINE	1
18	05783012	BOLT M12 - GB5783	4	47	18070000	BASE ASSY. OF ENGINE	1
19	00180301	RUBBER WHEEL (FRONT)	2	48	05784010	BOLT M10 X 30 - GB5784	8
20	18030102	DEEP WASHER	2	49	09300010	SPRING WASHER 10 - GB93	8
21	09300008	SPRING WASHER 8 - GB93	2	50	09700010	WASHER 10 - GB97	8
22	05780008	BOLT M8 X 20 - GB5780	2	51	06178012	NUT M12 - GB6178	3
23	18080000	BLADE GUARD	1	52	08480012	WASHER 12 - GB848	1
24	09600010	WASHER 10 - GB96	1	53	05780012	BOLT M12 X 45 - GB5780	1
25	05781010	BOLT M10 - GB5781	1	54	18010001	POINTER	1
26	06200010	NUT M10 - GB62	1	55	05780012	BOLT M12 X 110 - GB5780	1
27	09600010	WASHER 10 - GB96	1	56	18010002	NUT	1
28	00180008	SCREW	1	57	08480012	WASHER 12 - GB848	1
29	05780010	BOLT M10 X 25 - GB5780	1	58	18010003	POINTER WHEEL	1
30	18090001	WASHER	1	98	18110002	INNER BELT GUARD	1
31	09300010	SPRING WASHER 10 - GB93	1	99	18110003	OUTER BELT GUARD	1
32	18090005	PULLEY	1	100	18110004	BOLT M10X35-GB5780	2
33	00180902	BEARING & BRACKET	2	101	18110005	WASHER 10	2
34	01096008	KEY C8 X 38 - GB1096	1	--	----	-----	--

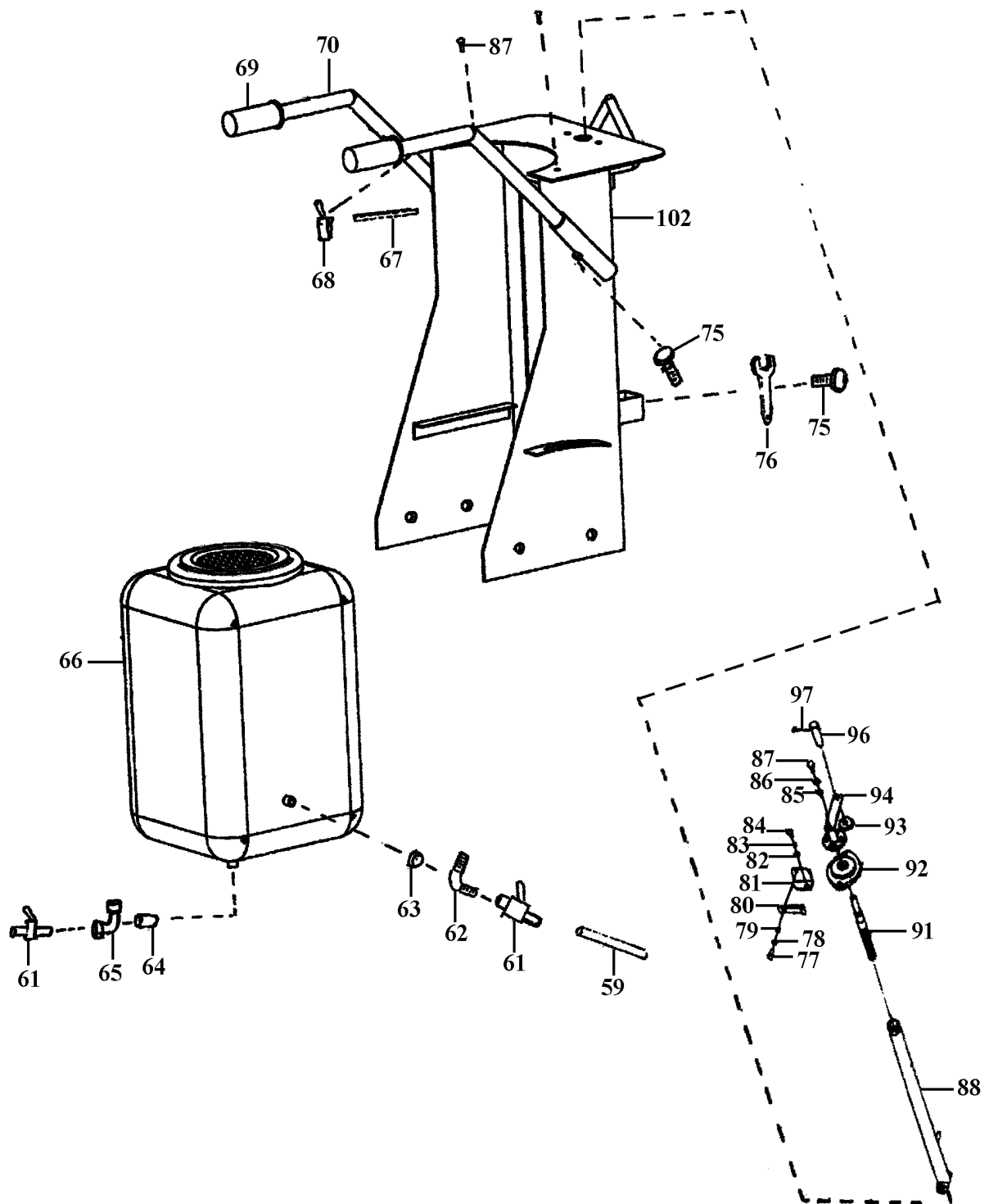

MF16 PARTS LIST 2

MF16 PARTS LIST 2

ITEM NO.	PART NO.	DESCRIPTION	QTY
59	00180006	PLASTIC PIPE	3
61	00180002	COCK	2
62	18050006	ELBOW BEND	1
63	00180501	NUT	1
64	00180502	NUT	1
65	18050011	ELBOW	1
66	18050000-1	WATER TANK	1
67	00180009	THROTTLE CABLE	1
68	00180010	THROTTLE CONTROL	1
69	00180011	HANDLE BAR GRIP	2
70	18060000-1	HANDLE LEVER	2
75	00180004	KNOB	3
76	00180001	WRENCH	1
77	05781008	BOLT M8 X 30 - GB5781	1
78	09300008	SPRING WASHER 8 - GB93	1
79	09700008	WASHER 8 - GB97	1
80	18030006	BOARD PLUG	1
81	18030007	ORIENTATION BOARD	1
82	09700010	WASHER 10 - GB97	2
83	09300010	SPRING WASHER 8 - GB93	2
84	05781010	BOLT M10 - GB5781	2
85	08480008	WASHER 8 - GB848	1
86	09300008	SPRING WASHER 8 - GB93	1
87	05784008	BOLT M8 X 20 - GB5784	1
88	18030200	MANUAL RAISE/LOWER ASSY.	1
91	18030005	SCREW	1
92	00180301	BEARING & BRACKET	1
93	06187010	NUT M10 - GB6787	1
94	18030400	BRACKET	1
96	18030404	HANDLE GRIP	1
97	07300006	BOLT M6 - GB73	1
102	18050012	WATER TANK HOLDER ASSY	1



Distributed By



MASALTA ENGINEERING CO., LTD

Add: Weisi Road, Baohe Industrial Estate, Hefei, China
Tel: 86-551-4846600, 4846601 Fax: 86-551-4846616
E-mail: sales@masalta.com.cn, masalta@mail.hf.ah.cn,
[Http://www.masalta.com.cn](http://www.masalta.com.cn)