

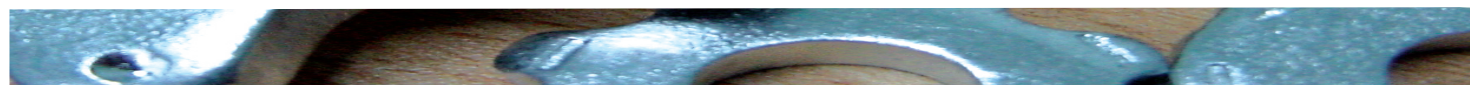

**MASALTA**<sup>®</sup>



# INSTRUCTION MANUAL TAMPING RAMMER EMR70H



**WARNING**



To reduce the risk of injury, all operators and maintenance personnel must read and understand these instructions before operating, changing accessories, or performing maintenance on Masalta power equipment. All possible situations cannot be covered in these instructions. Care must be exercised by everyone using, Maintaining or working near this equipment.

## Contents

<b>Introduction</b> .....	1
<b>Application</b> .....	2
<b>Operating safety</b> .....	2-4
<b>Label locations</b> .....	4
<b>Safety and Operating Labels</b> .....	5-6
<b>Prior to Starting the Operation</b> .....	6-7
<b>Operation</b> .....	7-8
<b>Service and Maintenance</b> .....	8-9
<b>Specification</b> .....	9
<b>Transportation</b> .....	10
<b>Trouble shooting</b> .....	10-11
<b>Warranty and Maintenance Record</b> .....	12

## Introduction

Thanks for your selection of this equipment. We have taken care in the design, manufacture and testing of the product. It is covered by a six month warranty. Should service or spare parts be required, prompt and efficient service is available from our company or our agent.

### Definition of Tamping Rammer

Tamping Rammer is a compacting machine, capable of quickly working by applying consecutive impacts to the surface of soil-in order to level the uneven soil surface, to compact the soil uniformly so that the void among soil particles are minimized and to increase its dry density with moisture in the soil removed.

### Construction of Tamping Rammer

Air-cooled engine has been installed as its source of power.

Transmission of the power is taken place by increasing engine speed to engage a centrifugal clutch, and the speed is substantially reduced by means of gears and rotational motion is converted into reciprocal (vertical) motion.

A heavy duty spring is installed at the part that moves up and down so that its force and the weight of tamping rammer work each other to develop powerful compacting force at the foot of the rammer. Proper service and operation are essential for full commissioning of such performance.

## Application

Rammers are designed to compact loose soils and gravel to prevent settling and to provide a firm, solid base for the placement of footings, concrete slabs, foundations, gas piping works, water pipe works and cable backfill works, etc.



### Warnings for incorrect application and abuse

Please do not use in such as following cases. It may cause damage because machine is likely to be unbalanced.

- I Pile foundation
- I Hard soil excessively compacted over normal condition
- I Steep bank slope

Tamping Rammer is to be used for compacting cohesive clay, gravels, and patching work on asphalt, etc.

### Structure

The upper part is made up of Power source, Clutch, Connecting Rod and Operating Handle, Fuel Tank that connected via Shock Absorbing Rubber to body. Bottom end is made up of Spring Cylinder (Sliding part), Foot Plate that ramps body, Foot and Bellows that covers sliding part.

## Operating Safety

### Safety Notes

This manual contains NOTES, CAUTIONS, and WARNINGS which must be followed to prevent the possibility of improper service, damage to the equipment, or personal injury.

**Notes:** Notes contain additional information important to a procedure.

**CAUTION:** Cautions provide information important to prevent errors which could damage machine or components.



### WARNING

**Warnings warn of conditions or practices which could lead to personal injury or death!**

### Operating Safety

Familiarity and proper training are required for the safe operation of equipment! Equipment operated improperly or by untrained personnel can be dangerous! Read the operating instructions and familiarize yourself with the location and proper use of all instruments and controls. Inexperienced operators should receive instruction from someone familiar with the equipment before being allowed to operate the rammer.

**NEVER** operate rammer in applications for which it is not intended.

**NEVER** allow improperly trained personnel to operate rammer.

**NEVER** touch hot muffler, engine cylinders, or cooling fins. Burns will result.

**NEVER** use accessories or attachments which are not recommended by MASALTA for rammer. Damage to rammer and/or injury to user may result.

**NEVER** leave a running machine unattended.

**NEVER** run machine indoors or in an enclosed area such as a deep trench unless adequate ventilation is provided. Exhaust gas from the engine contains poisonous carbon monoxide gas; exposure to carbon monoxide can cause loss of consciousness and may lead to death.

**NEVER** tamper with or disable the function of operating controls.

**NEVER** use choke to stop engine.

**NEVER** operate the machine in areas where explosions may occur.

**ALWAYS** remove or disconnect engine spark plug before servicing rammer, to avoid accidental start-up.

**ALWAYS** read, understand, and follow procedures in Operator's Manual before attempting to operate equipment.

**ALWAYS** be sure that all other persons are at a safe distance from the rammer. Stop the machine if people step into the working area of the machine.

**ALWAYS** be sure operator is familiar with proper safety precautions and operation techniques before using rammer.

**ALWAYS** wear protective clothing when operating rammer. Wear goggles or safety glasses, hearing protection, and safety shoes.

**ALWAYS** keep hands, feet, and loose clothing away from moving parts of rammer.

**ALWAYS** use common sense and caution when operating rammer.

**ALWAYS** be sure rammer will not tip over, roll slide, or fall when not being operated.

**ALWAYS** turn engine OFF when rammer is not being operated.

**ALWAYS** guide the rammer in such a way that the operator is not squeezed between the rammer and solid objects. Special care is required when working on uneven ground or when compacting coarse material. Make sure to stand firmly when operating the machine under such conditions.

**ALWAYS** operate the rammer in such a way that there is no danger of it turning over or falling in, when working near the edges of breaks, pits, slopes, trenches and platforms.

### **Operator Safety while using Internal Combustion Engines**

Internal combustion engines present special hazards during operation and fueling! Failure to follow the safety guidelines described below could result in severe injury or death.



#### **WARNING**

**DO NOT** smoke while operating rammer.

**DO NOT** smoke when refueling engine.

**DO NOT** refuel hot or running engine.

**NO NOT** refuel engine near open flame.

**DO NOT** spill fuel when refueling engine.

**DO NOT** operate rammer near open flames.

**ALWAYS** refill fuel tank in well-ventilated area.

**ALWAYS** replace fuel tank cap after refueling.

**ALWAYS** check fuel lines, fuel cap, and fuel tank for leaks and cracks before starting engine.

Do not run machine if fuel leaks are present, or fuel cap or fuel lines are loose.

### **Service Safety**

Poorly maintained equipment can become a safety hazard! In order for the equipment to operate safely and properly over a long period of time, periodic maintenance and occasional repairs are necessary.



## WARNING

DO NOT attempt to clean or service rammer while it is running.

DO NOT operate rammer with safety devices or guards removed or not in working order.

DO NOT operate rammer without air cleaner.

DO NOT remove air cleaner paper element, precleaner, or air cleaner cover while operating rammer.

DO NOT alter engine speeds. Run engine only at speeds specified in Technical Data Section.

ALWAYS replace safety devices and guards after repairs and maintenance.

ALWAYS keep area around muffler free of debris in order to reduce to chance of an accidental fire.

ALWAYS do Periodic Maintenance as recommended in Operator's Manual.

ALWAYS clean debris from engine cooling fins.



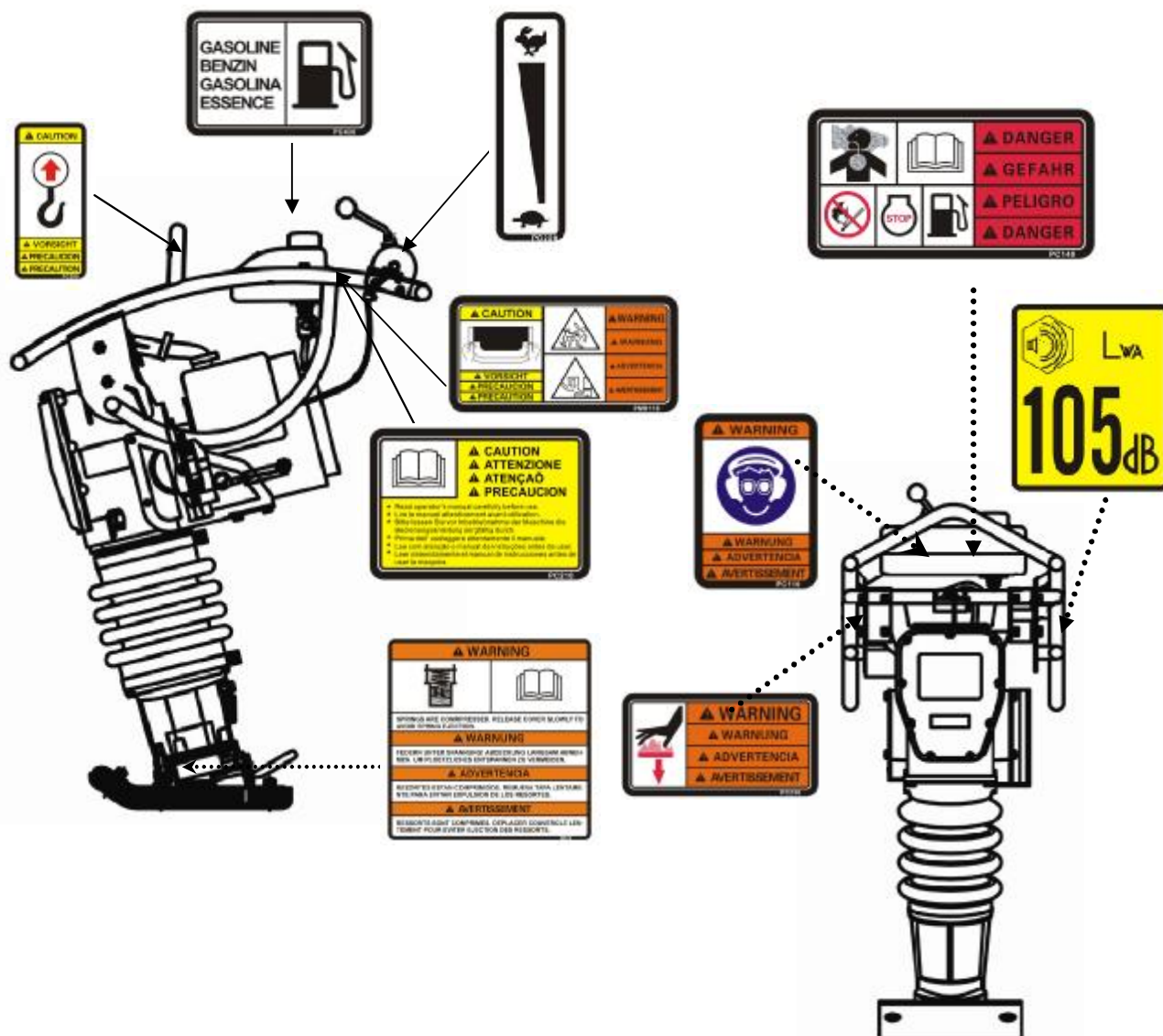

ALWAYS replace worn or damaged components with spare parts designed and recommended by MASALTA for servicing this rammer.





## Label Location



## Safety and Operating Labels

MASALTA machines use international pictorial labels where needed. These labels are described below:

Label	Meaning
	<p><b>DANGER!</b> Engines emit carbon monoxide; operate only in well-ventilate area. Read the Operator's Manual for machine information. No sparks, flames, or burning objects near the machine. Shut off the engine before refueling. Use only clean, filtered unleaded gasoline.</p>
	<p><b>WARNING!</b> Always wear hearing and eye protection when operating this machine.</p>
	<p><b>CAUTION!</b> Read and understand the supplied Operator's Manual before operating the machine. Failure to do so increase the risk of injury to yourself or others.</p>
	<p><b>CAUTION !</b> Lifting point.</p>
	<p><b>CAUTION!</b> Use only clean, filtered gasoline fuel.</p>
	<p><b>WARNING!</b> Hot surface!</p>

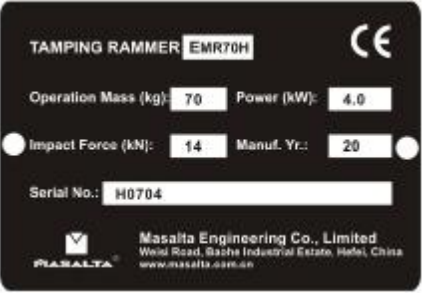
Label	Meaning
	<p><b>CAUTION!</b> For optimal control, performance, and minimal hand/arm vibration, grasp handle as shown.</p>
	<p><b>WARNING!</b> Serious injury if struck by compressed spring or cover. If the spring system cover is removed improperly, the springs can eject.</p>
	<p>Guaranteed sound power level in dB(A).</p>
	<p><b>NOTICE!</b> Throttle control lever: Turtle = Idle or Slow Rabbit = Full or Fast</p>
	<p>A nameplate listing the model number and serial number is attached to each unit. Please record the information found on this plate so it will be available if the nameplate lost or damaged. When requesting service information, the serial number should be specified of the unit.</p>

**Prior to Starting the Operation**

- I This machine is of oil bath lubrication system.
- I Check the oil level through a window at rear end of the foot. Replenish oil if oil is not visible at the window. For lubrication, use automobile engine oil of 10W-30 SE, SF or better grade. Capacity is 830cc.
- I Fill the fuel tank with regular gasoline (unleaded). Simultaneously, check engine oil and make it a habit to replenish on the earlier side. Low lubrication oil level may result in engine seizure due to consumption during operation. Nevertheless, oil level should be checked prior to start up without fail. For lubrication, use automobile engine oil of 10W-30 SE, SF or better grade. See Engine Operating Manual for further detail.

- I Check every bolt, nut or screwed area for tightness. ***Loosened due to vibration may result in unexpectedly serious trouble. Be sure to tighten any screwed area.***
- I Remove dirt and dust. Particularly clean the vicinity of recoil starter and foot.

## Operation

### Starting up for Petrol engine

1. Open the fuel shut-off valve by moving the fuel cock level to the open position.
2. Set the engine ON/OFF switch to the "ON" position.
3. Grip the recoil starter handle and pull it until you feel slight resistance. Then pull sharply and quickly. Return the recoil starter handle to the starter case before releasing.
4. Grip the recoil starter handle and pull it a little to feel a slight resistance. Then pull it powerfully from there. To release the handle do not release it at the position where it has been pulled to, but release it after returning closely to the starter case.
5. If the engine has started, while listening to explosion sounds, return the choke lever slowly to full-open position. Be sure to perform a warm-up run for the period 3 to 5 minutes at low speed, while paying careful attention to gas leakage or abnormal sound.
6. If it is difficult to start the engine by repeatedly pulling the starter rope, remove ignition plug and check the sparking performance. If the plug is wet due to excessive fuel intake or soiled, replace the coil or clean sufficiently to its internals. With the ignition plug removed, pull the recoil starter handle 2-3 times to discharge excessive blended gas.

### Starting up for machine

1. Turning the choke level to open the choke. Running the engine for 5 minutes at low speed to warm the engine.
2. Move the throttle level quickly to the "FULL OPEN" position. DO NOT move the throttle level slowly as this may cause damage to the clutch or spring.

**Caution:** Make sure that the throttle lever is moved to the FULL OPEN position. Operating the rammer at less than full speeds can result in damage to the clutch springs or foot.

3. After starting to tamping action, adjusts the jumping motion to suit particular soil condition by lightly controlling the throttle lever. When the engine speed falls between the set values shown on the engine, your work can be carried out at the best efficiently. Increasing the engine speed unnecessarily, does not cause the compaction force to increase. On the contrary, a resultant resonance causes the compaction force to decrease, damaging the machine.
4. Under cold weather, the oil in the machine being viscous, resistance at reciprocating part is greater causing the tamping rammer to perform somewhat irregular movement. Therefore, it is recommended to perform warm-up run while moving the throttle lever repeatedly between ON and OFF positions, before entering the work.
5. Soil contacting surface of the foot is lined with heat-treated metal sheet for extra strength. However, for compacting cobblestone, use the filling-up soil for example so that the foot hits the soil uniformly.
6. The tamping rammer has been designed to advance while jumping. For quicker advance, erect the machine by pushing its handle down slightly so that flat surface of the foot at its rear-end contacts the ground.
7. To stop the tamping action, move throttle lever quickly from the FULL OPEN to IDLE position.



## To Stop

### Normal shutdown

1. With the throttle lever closed from ON to OFF, run the engine for 3-5 minutes at low speed, and after temperature is lowered, turn the switch to the "OFF" position.
2. Close the fuel shut-off valve by moving the fuel cock lever to the CLOSED position.

### Emergency shutdown

Move the throttle lever quickly to the IDLE position, and turn the engine ON/OFF switch to the OFF position.

## Maintenance and Storage:

### Periodic Maintenance Schedule

	Daily Before Starting	After First 5 hours	Every Week or 25 hours	Every month or 100 hours	Every 3 months or 300 hours
Check fuel level.	●				
Check oil level of machine.	●				
Check fuel line and fittings for cracks or leaks.	●				
Tighten ramming shoe hardware.		●	●		
Check and tighten engine cylinder screws.		●	●		
Check and tighten external hardware.		●	●		
Clean engine cooling fins.			●		
Clean and check spark plug gap.			●		
Replace spark plug.				●	
Clean recoil starter.					●
Change ramming system oil. *					●
Clean engine muffler and exhaust port.					●

\* **Change ramming system oil after first 50 hours of operation.**

Note: If engine performance is poor, check, clean, and replace air filter elements as needed.

### Air Cleaner Cleaning for EMR70H (6 to 12 months Service):

Remove element from pre-cleaner at the top of crank case and clean it with cleaning oil (kerosene). Take of 'Bolt, Cover' of the crankcase upper part and take 'Element' off 'AIR CLEANER'. Wet the bottom element (gray) with 7-9cc and let upper element (yellow) be familiar with oil.

## Storage

Rammer should be stored in such position as it is placed on level, after engine and machine have been cooled down. Be sure to secure the rammer as necessary to avoid falling down. If the rammer has to be laid down inevitably, tighten fuel tank cap and engine oil plug securely and wait until engine and machine are cooled down. After laying it down, make sure that there is no leak of fuel or oil. (If fuel leaks, drain the tank)

## Long-Term Storage

- I Drain fuel from fuel tank, fuel line and carburetor.
- I Remove spark plug and pour a few drops of motor oil into cylinder. Crank engine 3 to 4 times so that oil reaches all internal parts.
- I Clean exterior with a cloth soaked in clean oil.
- I Store unit covered with plastic sheet in moisture free and dust free location out of direct sunlight.

## Specification

Model	EMR70H
Motor	Honda GX160
Power kW (hp)	4.0 (5.5)
Operation Mass kg (lb)	70 (154)
Impact Force kN	14
Jumping Stroke mm	50-80
Fuel Tank Capacity L	2.8
Shoe Size mm	350X285

## Acoustic Noise (According to 2000/14/EC)

	EMR70H
Measured sound power level	105dB
Guaranteed sound power level	107dB

**Working Size** (L x W x H): 689X440X1080 mm

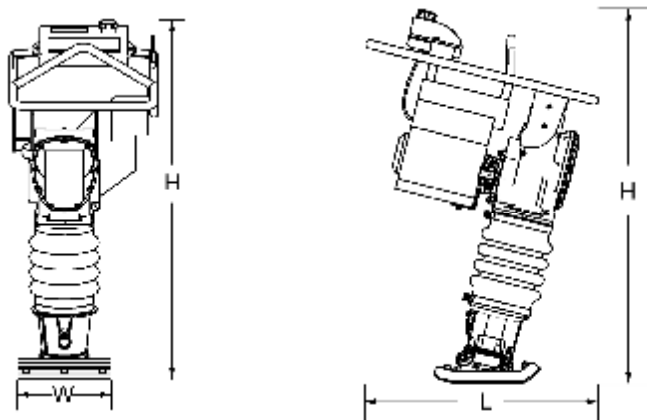

**Hand-Arm vibration** Specification (According to ISO 5394, EN 1033 and EN500-4): 7.2m/s<sup>2</sup>

## Transportation

1. Shutdown engine for transportation.
2. For transportation, tighten fuel tank cap securely and close fuel cock to prevent fuel from spilling.
3. Drain fuel for transportation over long distance or bad road.
4. Secure machine firmly to prevent it from moving or tipping.
5. Rammer should be transported in such position as it is placed on level ground. In case of it must be laid down for transportation, drain fuel tank as well as carburetor and make sure that oil plug is tightened securely.
6. Direction to lay down the rammer, must be such that air cleaner comes to top. After laying it, make sure that there is no leak of oil or residual fuel.
7. Make sure lifting device has enough capacity to hold machine (see identification plate on machine for weight). Use central lifting point (a) when lifting machine.
8. Use trolley kit (supplied as optional) for short distance transportation.



## Troubleshooting Guide

### A. Rammer Troubleshooting

SYMPTOM	POSSIBLE PROBLEM	SOLUTION
Engine rotates but amplitude not uniform or does not strike	Operating speed of throttle lever is incorrectly set?	Set throttle lever to correct position.
	Oil in excess?	Drain excess oil. Bring to correct level.
	Clutch slips?	Replace or adjust clutch.
	Spring Failure?	Replace spiral spring.
	Speed of engine improper?	Adjust engine speed to correct operating RPM setting.

## B. Engine Troubleshooting Guide

SYMPTOM	POSSIBLE CAUSE	SOLUTION
Difficult to start		
Fuel is available but spark plug will not ignite.(Power available at high tension code.)	Ignition plug being bridging?	Check ignition system.
	Carbon deposit at ignition?	Clean or replace ignition.
	Short circuit due to deficient insulator?	Replace insulators.
	Improper spark gap?	Set spark plug gap to the correct gap.
fuel is available but spark plug will not ignite.(Power NOT available at high tension code.)	Short circuit at stop switch?	Check stop switch circuit. Replace stop switch if defective.
	Ignition coil defective?	Replace ignition coil.
Fuel is available and spark plug ignites (compression normal).	Muffler clogged with carbon deposits?	Clean or replace muffler.
	Mixed fuel quality is inadequate?	Check fuel to oil mixture.
	Fuel in use inadequate (water, dust)?	Flush fuel system and replace with fresh fuel.
	Air cleaner clogged?	Clean or replac air cleaner.
Fuel is available and spark plug ignites (compression normal).	Defective cylinder head gasket?	Tighten cylinder head bolts or replace head gasket.
	Cylinder worn?	Replace cylinder.
	Spark plug loose?	Tighten spark plug.
Operation not satisfactory		
Not enough power available (compression normal, no missfiring)	Air cleaner clogged?	Clean or replace air cleaner.
	Air in fuel line?	Bleed (remove air) from fuel line.
	Fuel level in carburetor float chamber improper?	Adjust carburetor float.
	Carbon deposit in cylinder?	Clean or replace cylinder.
Not enough power available (compression normal, no missfiring)	Ignition coil defective?	Flush fuel system and replace with fresh fuel.
	Ignition plug often shorts?	Replace ignition wires, clean ignition.
	Fuel in use inadequate (water, dust)?	Flush fuel system and replace with fresh fuel.
Engine overheats.	Mixed fuel quality is inadequate?	Check fuel to oil mixture.
	Excessive carbon deposition in combustion chamber?	Clean or replace crankcase.
	Exhaust or muffler clogged with carbon?	Clean or replace muffler.
	Spark plug heat value incorrect?	Replace spark plug with correct type spark plug.
Rotational speed fluctuates.	Governor adjustment improper?	Adjust governor to correct lever.
	Gvoernor spring defective?	Clean or replace ignition.
	Fuel flow erratic?	Check fuel line.
	Air taken in through suction line?	Check suction line.
Recoil starter not working properly.	Dust in rotating part?	Clean recoil starter assembly.
	Spring spring failure?	Replace sprial spring.





*Distributed By*

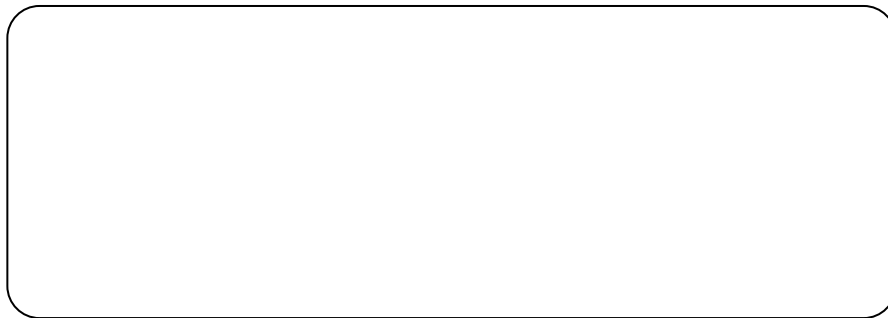

MASALTA ENGINEERING CO., LTD

Add: 20 Dalian Road, Baohe Industrial Estate, Hefei, China

Tel: 86-551-64846601, 64846580 Fax: 86-551-64846616, 64846626

E-mail: sales@masalta.com.cn, masalta@mail.hf.ah.cn

Http://www.masalta.com.cn